

KRN100 Series

Features

- Combined functions of paper recorder and paperless recorder
- Enables to print the saved data of inner memory when running out of recording paper (data logger function)
- Enables to set parameters with USB, RS485, Ethernet communication
- High legibility and setting convenient by graph LCD
- High speed sampling of 25ms, high speed record of 240mm/H functions
- 100mm paper record (selectable 6 kinds of record color)
- Supports inner memory and USB memory data backup (storage)
- Supports several input up to 12 channels with slot type input cards
- Enables to select several option cards with slot type output cards
- Space saving for installation with compact design (rear length: 168mm)
- Supports total 27 kinds of input types
- Enables to order several type input cards (weight, voltage, current, frequency, potential meter, etc)

CE



Please read "Safety Considerations" in operation manual before using this unit.

Manual

- For more information and instructions, refer to the user manual and the user manual for communication. Visit our web site (www.autonics.com) to download the manuals.
- The user manual includes product specifications, functions, and operations.
- The user manual for communication includes information about Modbus RTU protocol, Modbus TCP protocol, and Modbus mapping table.

Comprehensive Device Management Program (DAQMaster)

- DAQMaster is the comprehensive device management program to set parameters and manage monitoring data.
- Visit our website (www.autonics.com) to download user manual and comprehensive device management program.

< Computer specification for using software >

Item	Minimum requirements
System	IBM PC compatible computer with Intel Pentium III or above
Operating system	Microsoft Windows 98/NT/XP/Vista/7/8/10
Memory	256MB or more
Hard disk	More than 1GB of free hard disk space
VGA	1024 × 768 or higher resolution display
Others	RS-232 serial port (9-pin), USB port

< DAQMaster screen >



100mm Hybrid Recorder

Ordering Information

Ordering information for recorder model

KRN100	-	12	0	0	0	-	0	0	-	0	S
①		②	③	④	⑤		⑥	⑦		⑧	⑨

Item	Description	
① Item	KRN100	100mm Paper Type Recorder
② Input channel	02	2-channel (KRN-UI2 × 1)
	04	4-channel (KRN-UI2 × 2)
	06	6-channel (KRN-UI2 × 3)
	08	8-channel (KRN-UI2 × 4)
	10	10-channel (KRN-UI2 × 5)
	12	12-channel (KRN-UI2 × 6)
③ Digital inputs	0	None
	1	6 (KRN-DI6 × 1)
	2	12 (KRN-DI6 × 2)
④ Alarm transistor outputs	0	None
	1	6 (KRN-AT6 × 1)
	2	12 (KRN-AT6 × 2)
⑤ Alarm relay outputs	0	None
	1	4 (KRN-AR4 × 1)
	2	8 (KRN-AR4 × 2)
	3	12 (KRN-AR4 × 3)
⑥ Transmitter power outputs	0	None
	1	3 (KRN-24V3 × 1)
	2	6 (KRN-24V3 × 2)
	3	9 (KRN-24V3 × 3)
	4	12 (KRN-24V3 × 4)
⑦ Communication output	0	None
	1	RS485/Ethernet/USB (KRN-COM × 1)
⑧ Power voltage	0	100-240VAC 50/60Hz
⑨ Case	S	Standard panel mounting type

Ordering information for input/output card

Type	Model	Function and number of channels	Max. mountable cards	Slot number
Universal input card	KRN-UI2	Universal input 2-channel	6	1 to 6
Digital input card	KRN-DI6	Digital input 6-channel	2	7 to 10 ^{※1}
Alarm output card	KRN-AR4	Alarm relay output 4-channel	3	
	KRN-AT6	Alarm transistor output 6-channel	2	
Transmitter power output card	KRN-24V3	Transmitter 24VDC power output 3-channel	4	
Communication output card	KRN-COM	RS485 + USB + Ethernet communication output	1	C

※ 1. The digital input card, alarm output card, transmitter power output card are connectable up to 4 cards as mixed.

Example of ordering

To use universal input 10-channel, digital input 4-channel, alarm relay output 5-channel, and RS485 communication output, it is ordered as KRN100-10102-01-0S and the connected I/O card is as below.

- KRN100 (recorder): 1
- KRN-UI2 (universal input card): 5 (One universal input card is 2-channel and 5 cards × 2-channel = 10-channel.)
- KRN-DI6 (digital input card): 1
- KRN-AR4 (alarm relay output card): 2
- KRN-COM (communication output card): 1

A. Recorders

B. Indicators

C. Converters

D. Controllers

E. Thyristor Power Controllers

F. Pressure Transmitters

G. Temperature Transmitters

H. Accessories

KRN1000

KRN100

KRN50

KRN100 Series

Connections

■ Rear side of KRN100 standard model

This figure is the rear side of KRN100-04000-00-0S.

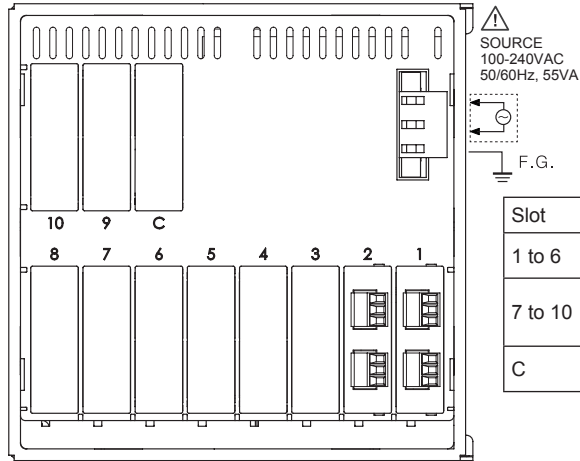

Slot	Description
1 to 6	Connects universal input card (KRN-UI2).
7 to 10	Connects digital input card (KRN-DI6), alarm output card (KRN-AR4, KRN-AT6), transmitter power output card (KRN-24V3).
C	Connects communication output card (KRN-COM).

■ I/O card

<p>Universal input card [KRN-UI2]</p> <p>※Each channel is isolated and dielectric strength is 500V.</p>	<p>Digital input card [KRN-DI6]</p>
<p>Alarm output card [KRN-AR4 (relay output)]</p> <p>Alarm Output Relay Contact 250VAC 3A 1a RESISTIVE LOAD</p>	<p>Alarm output card [KRN-AT6 (transistor output)]</p> <p>Alarm Output NPN Open Collector 12-24VDC / 30mA Max. RESISTIVE LOAD</p> <p>※AL1,2,3 and AL4,5,6 are isolated.</p>
<p>Transmitter power output card [KRN-24V3]</p> <p>※Each 24V output is isolated individually.</p>	<p>Communication output card [KRN-COM]</p>

100mm Hybrid Recorder

Specifications

Series	KRN100	
Power voltage	100-240VAC~ 50/60Hz	
Allowable voltage range	85 to 110% of rated voltage	
Power consumption	Max. 55VA	
Screen	LCD type	STN Graphic LCD
	Resolution	320 × 120Pixel
	Adjusting brightness	4-level (OFF/Min/Standard/Max)
	Backlight	White LED, 2-level (Temp/Always)
Input channels	2 / 4 / 6 / 8 / 10 / 12-channel (2-channel/card)	
Universal input ^{※1}	Temperature sensor (RTD, thermocouple), analog (voltage, current)	
Sampling period	1 to 4-channel: 25ms/125ms/250ms, 5 to 12-channel: 125ms/250ms (inner sampling period is operation unit time for average movement filter and alarm output function.) ※Min. sampling period for TC-R, U, S, T sensor is 50ms.	
Recording speed in graph mode	10, 20, 40, 60, 120, 240mm/H	
Recording speed accuracy	F.S. ±0.5%	
Storage cycle	1 to 3600 sec (storage interval time to inner log file is 1 sec)	
Inner memory	512MB	
USB memory	User purchased, recognizes max. 32GB, enables to use cable up to 1.5m	
Dielectric voltage	2500VAC 50/60Hz for 1 min (power terminal and case) ※Excepts USB Device and Ethernet	
Vibration strength (for convey and storage) and operating vibration	Vibration strength: 10 to 60Hz 4.9m/s ² (each X, Y, Z axis for 1 hour) Operating vibration: 10 to 60Hz 1m/s ² (each X, Y, Z axis for 10 min)	
Insulated resistance	Over 20MΩ (at 500VDC megger)	
Noise immunity	±2kV the square wave noise (pulse width 1μs) by the noise simulator	
Time accuracy	Within ±2 min/year (enables to use up to 2100 year)	
Mech- anism	Ink cartridge	Enables to normal print with going and returning printing max. 5 times within 7 days after opening the unit
	Ink dry time	Max. 15 minutes
Protection	IP40 (for front panel)	
Recording paper	113mm × 9m	
Environ- ment	Ambient temperature	0 to 50°C, storage: -20 to 60°C (without ink cartridge)
	Ambient humidity	35 to 85%RH, storage: 35 to 85%RH
Approval	CE	
Weight ^{※2}	Approx. 2.4 to 2.7kg (approx. 1.7 to 2.0kg)	

A. Recorders

B. Indicators

C. Converters

D. Controllers

E. Thyristor
Power
Controllers

F. Pressure
Transmitters

G. Temperature
Transmitters

H. Accessories

KRN1000

KRN100

KRN50

- ※ 1. For more information of universal input, please refer to 「I/O card」 of the A-5 page.
- ※ 2. The weight includes packaging. The weight in parenthesis is for unit only.
- ※ Environment resistance is rated at no freezing or condensation.

Dimensions

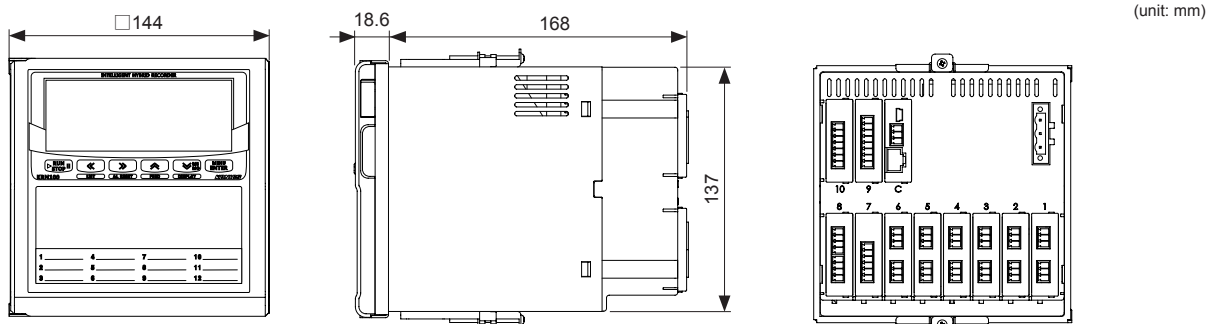

• Panel cut-out

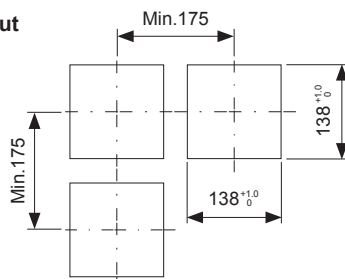

※ This rear side dimension is with installed I/O cards to every slot.

※ Use a steel plate which is 2 to 8mm thickness.

KRN100 Series

■ I/O card

Type	Model	I/O specifications		Descriptions
Universal input card	KRN-UI2	Input type* ¹	RTD	JPt100Ω, DPt100Ω, DPt50Ω, Cu100Ω, Cu50Ω (supply current 420μA)
			Thermocouple	B, C (W5), E, G, J, K, L, L (Russia), N, P, R, S, T, U
			Analog	Voltage: ±60mV ±200mV ±2V, 1-5V, ±5V, -1V-10V Current: 0.00-20.00mA, 4.00-20.00mA
		Input impedance		Voltage (V): min. 150kΩ RTD, Thermocouple, Voltage (mV): min. 2MΩ Current: 51Ω
		Display accuracy* ²	RTD	Warm-up time: min. 30 min Room temperature (25°C±5°C): ±0.1%F.S ±1digit Out of room temperature range: ±0.2%F.S ±1digit For RTD, 500 to 800°C is ±0.5%±1digit of PV value, For Thermocouple, below -100°C is ±0.3%F.S.±1digit.
			Thermocouple	
Analog				
Resolution		16bit		
Digital input card	KRN-DI6	Non-contact input		ON: max. 1V of residual voltage, OFF: max. 0.1mA of leakage current
		Contact input		ON: max. 1kΩ, OFF: min. 100kΩ, Outflow current for short: approx. 4mA
Alarm output card	KRN-AR4	Alarm relay output	Capacity	250VAC~ 3A, 30VDC= 3A, 1 Form A (resistance load)
			Life	Mechanical: min. 50,000,000 operations Electrical: min. 100,000 operations (250VAC~ 3A, 30VDC= 3A)
	KRN-AT6	Alarm transistor output		NPN open collector, 12-24VDC/30mA Max.
Transmitter power output card	KRN-24V3	Transmitter power output		24±2VDC=, total 3 channels, max. 30mA per 1 channel built-in over-current protection circuit
Communication output card* ³	KRN-COM	Com. output	RS485	Modbus RTU ※Recommended to use shield cable over AWG24
			EtherNet	IEEE802.3 (U), 10/100 BASE-T (Modbus TCP)
			USB Device* ⁴	USB V2.0 Full Speed (Device Control)

※1. To change input specification, you must turn OFF the power of KRN100, remove universal input cards, set inner jumper pins (please refer to '■ I/O card' of the A-3 page) and re-connect it.

※2. Exception range for measuring accuracy by each sensor (accuracy after 30 min warm-up time)

- R,S,C,G: 0≤T≤100±4.0°C
- B: No regulation accuracy below 400°C
- U,T: -200≤T≤-100±3.0°C, -100≤T≤400±2.0°C
- Cu50: -200≤T≤200±1.0°C
- DPt50: -200≤T≤600±1.5°C

※3. RS485, Ethernet communication output are not available at the same time.

※4. The front USB device is only for data backup and rear USB device is available only for parameter setting.

※ It is recommended to use shield cable to decrease noise when sensor input cable is longer.

※ **If connecting or disconnecting input/output card when power is ON, it may cause malfunction.**

To connect or disconnect input/output card, you must turn OFF the power.

100mm Hybrid Recorder

Input Type and Range

Input type		Display	Input range		
			°C	°F	K
Thermocouple	K (CA)	TC-K	-200.0 to 1350.0	-328.0 to 2462.0	73.2 to 1623.2
	J (IC)	TC-J	-200.0 to 800.0	-328.0 to 1472.0	73.2 to 1073.2
	E (CR)	TC-E	-200.0 to 800.0	-328.0 to 1472.0	73.2 to 1073.2
	T (CC)	TC-T	-200.0 to 400.0	-328.0 to 752.0	73.2 to 673.2
	B (PR)	TC-B	100.0 to 1800.0	212.0 to 3272.0	373.2 to 2073.2
	R (PR)	TC-R	0.0 to 1750.0	32.0 to 3182.0	273.2 to 2023.2
	S (PR)	TC-S	0.0 to 1750.0	32.0 to 3182.0	273.2 to 2023.2
	N (NN)	TC-N	-200.0 to 1300.0	-328.0 to 2372.0	73.2 to 2023.2
	C (TT)* ¹	TC-C	0.0 to 2300.0	32.0 to 4172.0	273.2 to 2573.2
	G (TT)* ²	TC-G	0.0 to 2300.0	32.0 to 4172.0	273.2 to 2573.2
	L (IC)	TC-L	-200.0 to 900.0	-328.0 to 1652.0	73.2 to 1173.2
	L (Russian type)* ³	TC-L_R	0 to 600.0	32.0 to 1112.0	273.2 to 873.2
	U (CC)	TC-U	-200.0 to 400.0	-328.0 to 752.0	73.2 to 673.2
	Platinel II	TC-P	0.0 to 1350.0	32.0 to 2462.0	273.2 to 1623.2
RTD	Cu50Ω	CU50	-200.0 to 200.0	-328.0 to 392.0	73.2 to 473.2
	Cu100Ω	CU100	-200.0 to 200.0	-328.0 to 392.0	73.2 to 473.2
	JPt100Ω	JPT100	-200.0 to 600.0	-328.0 to 1112.0	73.2 to 873.2
	DPT50Ω	DPT50	-200.0 to 600.0	-328.0 to 1112.0	73.2 to 873.2
	DPT100Ω	DPT100	-200.0 to 850.0	-328.0 to 1562.0	73.2 to 1123.2
Analog	Voltage	-60.00 - 60.00mV	±60mV	Resolution: 10μV	-99999 to 99999 (display range depends on the decimal point position)
		-200.00 - 200.00mV	±200mV	Resolution: 10μV	
		-2.000 - 2.000V	±2V	Resolution: 1mV	
		1.000 - 5.000V	1-5V	Resolution: 1mV	
		-5.000 - 5.000V	±5V	Resolution: 1mV	
		-1.00 - 10.00V	-1V-10V	Resolution: 10mV	
	Current	0.00 - 20.00mA	0-20mA	Resolution: 10μA	
		4.00 - 20.00mA	4-20mA	Resolution: 10μA	

A. Recorders

B. Indicators

C. Converters

D. Controllers

E. Thyristor Power Controllers

F. Pressure Transmitters

G. Temperature Transmitters

H. Accessories

KRN1000

KRN100

KRN50

※ 1. C (TT): Same as existing W5 (TT) type sensor

※ 2. G (TT): Same as existing W (TT) type sensor

※ 3. Russian type L type temperature sensor is divided from general purpose L type.

※ **When changing input type to voltage (over ±2V) or current, set the jumper pin of KRN-UI2 (universal input card). Its factory default is temperature sensor input.**

KRN100 Series

Unit Description

Front and side part

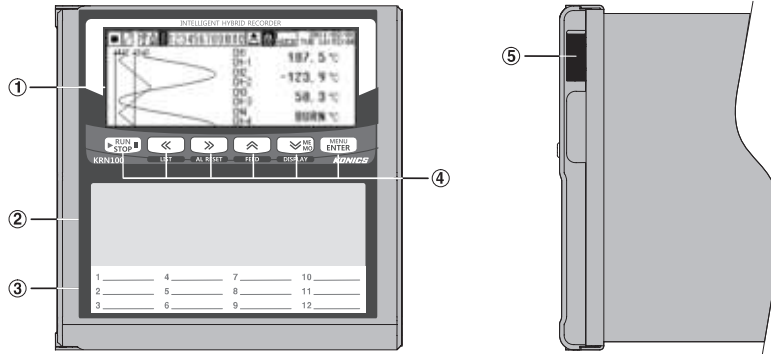

- ① Display part: Displays measurement values as trend graph, bar graph, or digital number (1/8/12-channel). Please refer to 「Display changing」 of the A-12 page.
- ② Recording print part: Records measuring value of data by each channel with designated color.
- ③ Channel information part: Write the information by each channel.
- ④ Control key/Function key: Executes parameter setting and recording, and special function.

Key	Function
	Used for starting/stopping recording, changing input characters on virtual keyboard status, and displaying Function key. Press this key for 3 sec in stop state, the ink cartridge moves to the center. (Use this key to replace the ink cartridge.)
	Used for going out from parameter setting group or setting manual channel switch mode. It also executes to release auto channel switch mode and printer list output (3 sec) function.
	Used for moving parameter in setting mode, setting manual channel switch mode and forced alarm reset (3 sec).
	Used for moving parameter in setting mode, increasing digit value, setting auto channel switch mode, and manual feed function (by pressing over 3 sec) in stop state.
	Used for moving parameter in setting mode, decreasing digit value, changing display mode and executing manual digital memo (3 sec) in recording state.
	Used for entering setting mode (3 sec) and set value change mode.

- ⑤ USB port :Connects an USB memory. It recognizes max. 32GB and if using cable, it is available up to 1.5m.

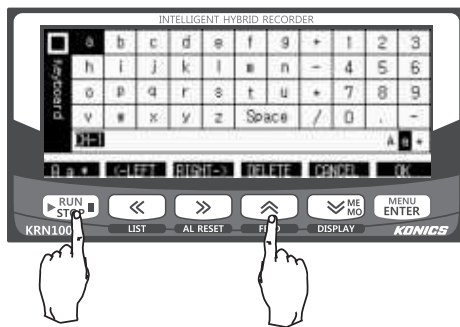

※ Function key:

Use this key to enter virtual keyboard in parameter setting.

Press the key and Function key appears on lower screen as

below figure. Press the , , , , key as below

Function key, it operates the appropriate Function key's operation.



Rear part

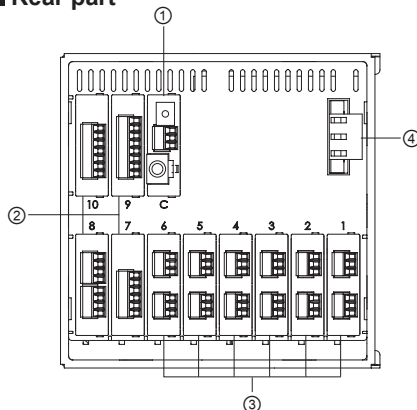

- ① Slot (C) for connecting communication output card (KRN-COM)
- ② Slot (7to10) for connecting digital input card (KRN-DI6), alarm relay output card (KRN-AR4), alarm transistor output card (KRN-AT6), transmitter power output card (KRN-24V3).
You can connect total 4 cards by combining digital input card, alarm output card, and transmitter power output card, as below combination example.

KRN-DI6 : 1	+	KRN-AR4 : 1	+	KRN-AT6 : 1	+	KRN-24V3 : 1	=	Total: 4
KRN-DI6 : 2	+	KRN-AR4 : 1	+	KRN-AT6 : 1	=	Total: 4		
KRN-DI6 : 1	+	KRN-24V3 : 3	=	Total: 4				

- ③ Slot (1 to 6) for connecting universal input card (KRN-UI2)

- ④ Power connecting part (100-240VAC 50/60Hz)

※ Above the rear side image is connected every output card to help your understand.

100mm Hybrid Recorder

Inside

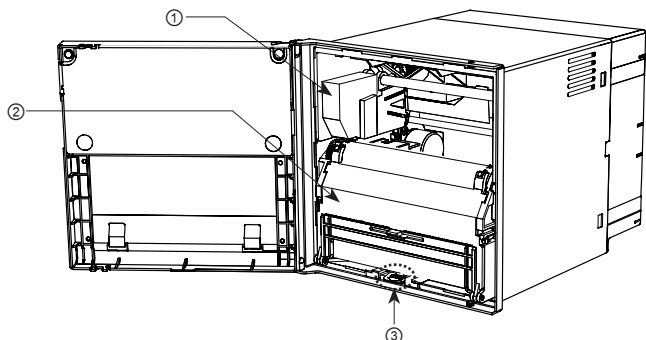

- ① Ink cartridge (model: D33006B-66X-01)
 - ② Recording paper cassette
Cassette saves the recording paper.
 - ③ Recording paper cassette lever
Press the lever down and this recording paper cassette is removed from KRN100.
- ※ Remove the recording paper cassette for recording paper replacement, ink cartridge replacement.

Paper cassette

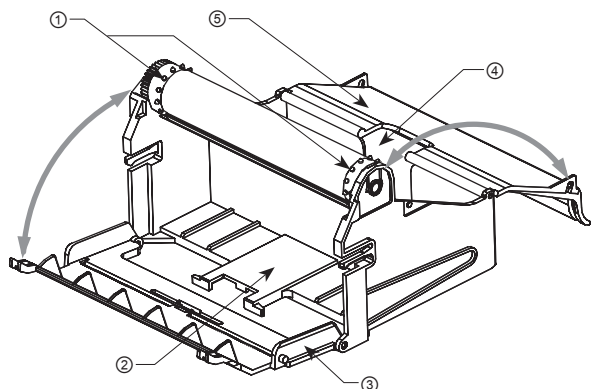

- ① Recording paper holder
Movement holder of recording paper when recording
- ② Recording paper storage part
Storage part for recorded recording paper
- ③ Front cover of recording paper storage
Open recording paper guide for recording paper replacement
- ④ New recording paper storage: Storage part for new recording paper (1 recording paper is storable.)
- ⑤ Rear cover of recording paper storage

Functions

Special function [Special Function]

It displays the applied measuring value of the set special function. Depending on Input Type (Input specification), applied special function is different.

- Setting range:
 - When input type (input specification) is temperature sensor (thermocouple, RTD): None ↔ Difference
 - When input type (input specification) is analog (voltage, current): Linear ↔ Root ↔ Square ↔ Two Unit
(Two Unit is displayed when Input Type (input specification) is set as 0-20mA, 4-20mA.)
- Factory default: None

⊙ Difference (deviation)

It is available to set when Input Type (input specification) is temperature sensor (thermocouple, RTD). It displays the deviation of Reference Channel (Reference channel) measuring value.

(Display value = standard channel measuring value - reference channel measuring value)

- The set channel as analog (current, voltage) of Input Type (Input specification) is not able to set as Reference Channel (reference channel).
- If there is no set reference channel, it displays standard channel measuring value.
- If any one of reference channel, or standard channel is break (BURN), upper limit value (HHHH), lower limit value (LLLL) status, it displays as correspond value. If you select the channel which is used Difference function as reference channel, it displays the value based on calculating actual measuring value, not display value of reference channel.

⊙ Linear

It applies lower limit scale and upper limit scale to lower limit input value and upper limit input value and displays this values.

E.g.) In case low limit input value: -5V, high limit input value: +5V and in case lower limit scale: -1000, upper limit scale: 1000, if current input value is 2V, display value is 400.

⊙ Root

In case voltage, current input type, this mode is used when input value is calculated by Root ($\sqrt{\quad}$) for the desired display value. Differential pressure signal of differential pressure flow meter is calculated Root ($\sqrt{\quad}$) for the to-be measured flux. This function is used to measure flux by input value.

E.g.) In case lower limit input value: -5V, upper limit input value: +5V and in case lower limit scale: -1000, upper limit scale: 1000, if current input value is 2V, display value is approx. 673.32.

⊙ Square

In case of voltage, current input type, this mode is used when input value is calculated by square of the desired display value. Reverse of Root, flux signal is calculated by square for differential pressure signal.

E.g.) In case lower limit range: -5V, upper limit range: +5V and in case lower limit scale: -1000, upper limit scale: 1000, if current input value is 2V, display value is -20.

A. Recorders

B. Indicators

C. Converters

D. Controllers

E. Thyristor Power Controllers

F. Pressure Transmitters

G. Temperature Transmitters

H. Accessories

KRN1000

KRN100

KRN50

KRN100 Series

◎ Two Unit

For compound pressure, if input pressure is lower than atmospheric pressure (0), it displays the degree of a vacuum with mmHg unit. If input pressure is higher than or same as atmospheric pressure (0), it displays positive pressure with kg/cm² unit.

When using Two Unit function, lower limit value is fixed as -760mmHg and kg/cm² value is able to set within setting range 1 to 35.

Two Unit limits scale point as 0 ↔ 0.0 ↔ 0.00. When using Two Unit, display unit is automatically changed as mmHg or kg/cm².

The calculation with Record Method (Data storage method) and Filter type (Input digital filter) is impossible and ignored due to different type of two unit value.

- Setting range: 1 to 35
- Factory default: -

E.g.) If pressure range is -760mmHg to 3kg/cm², and pressure transmitter outputs 4-20mA, for 4mA input it displays -760mmHg, 8mA input is unit changing point. For 20mA input, it displays 3kg/cm².

■ Record zone division [Divide Zone]

Divides record zone for measuring value by channel.

It divides equally max. 12 zones as equal value. User needs to set record zone by channel in Record Zone setting at Input Setup.

It is easy to check measuring value due not to duplicated record zone with divided record zone by channel which is set in Record Zone setting at Input Setup.

If there is too many division for record zone, record value check accuracy is low.

- Setting range: None, 2 to 12
- Factory default: None

E.g.) SV of record zone division: None

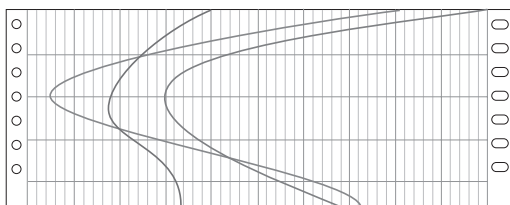

E.g.) SV of record zone division: 5

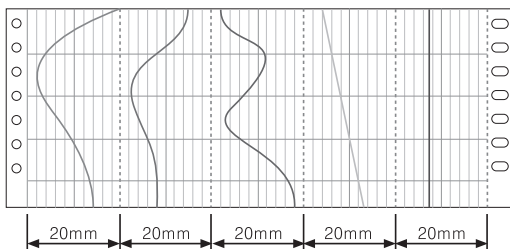

■ Summer time [Summer Time]

This function is for applying summer time (daylight saving time) in specific countries and regions.

When you set Summer Time, it adds current time and 1 hour and displays the 「(S)」 mark in front of the date and time on LCD screen or in front of the date on recording paper.

- Setting range: Disable ↔ Enable
- Factory default: Disable

■ Standard record period [Standard Period]

Set record period to record current time, display value by channel as digital number on recording paper.

It is activated when Record Mode (Record mode) is Digital.

- Setting range: 00m 01s to 99m 59s

Depending on the number of recording channels, min. setting range is limited as below.

Record channel	Setting range
1 to 2	01m 00s to 99m 59s
3 to 4	02m 00s to 99m 59s
5 to 6	03m 00s to 99m 59s
7 to 8	04m 00s to 99m 59s
9 to 10	05m 00s to 99m 59s
11 to 12	06m 00s to 99m 59s

- Factory default: -

■ Reservation record [Reservation Type]

This function is to set reservation time. At the set time, it starts/stops recording automatically.

You can select reservation record either Repeat (repeat ON/OFF) or Single (single ON/OFF).

When selecting reservation record, 'Reservation Period (Reservation record period)' and 'Reservation Time (Reservation record time)' are activated. When reservation record is set, the RE icon flashes with the ► (recording) or the ■ (stop recording) icon.

The RE icon turns OFF when reservation setting is 'Disable'.

- Setting range: Disable ↔ Repeat ↔ Single
- Factory default: Disable

◎ Repeat (repeat ON/OFF)



From start recording date to end recording date, it records data at from the set start time to the set end time.

◎ Single (single ON/OFF)

Starts recording at the start set time on start date and finishes recording at the end set time on end date.

■ File/Memory setup [FILE/MEMORY SETUP]

You can set the parameter about parameter set file and storage data. Move to FILE/MEMORY SETUP with the

  keys, press the  key to enter FILE/MEMORY SETUP.

◎ Open parameter set file [Load Set File]

Applies set value of saved parameter set file.

When applying this set, backup data, user unit and booting logo are not changed.

None. Default.pms file is activated and if there is User1.pms to User5.pms, User1.pms (USB) to User5.pms (USB) file (parameter set save file), it is activated.

- Setting range:
 - None ↔ Default.pms ↔ User1.pms to User5.pms
 - ↔ User1.pms (USB) to User5.pms (USB)
- Factory default: None

- ※ Be sure that if selecting 'Default.pms' file, every set value is initialized as factory default. Save the current set parameter as Save Set File (parameter setting file storage) at first and initialize it for the provision.
- ※ One file from User1.pms to User5.pms, User1.pms (USB) to User5.pms (USB) is selected, all parameter setting information of KRN100 is changed as the set value of the selected parameter save file.
- ※ Set value changing may be also affected to every setting of KRN100's overall operations. Check possible problems occurring on system and change the desired set value.

◎ Save parameter set file [Save Set File]

Saves current set parameter set value to inner memory or an external USB memory.

When saving it to inner memory, it is saved in User1.pms to User5.pms files or to an external USB memory, it is saved in User1.pms (USB) to User5.pms (USB) files. (Activated only when an external USB memory is connected.)

- Setting range:
 - None ↔ User1.pms to User5.pms, User1.pms (USB) to User5.pms (USB)
- Factory default: Select...

◎ USB storage function [USB LogData Save]

Set whether to save backup data which is saved at system on an USB memory.

When selecting Enable to saving data to USB memory, it also saves data to system memory at the same time. Connected an USB memory at left side USB Slot, KRN100 starts to save. It takes check time for storage free space approx. 10 to 60 sec depending on memory capacity.

The data is saved as 'KRN100_20100815 (year month day)_091050 (hour min sec).KRD' file name and if main set is changed or backup data capacity is over 100MByte, it creates a new file.

- Setting range: Disable ↔ Enable
- Factory default: Disable
- ※ Supporting file system is FAT16, FAT32 when using an USB memory. Microsoft's file system, NTFS, and Linux's file system, EXT2, EXT3, etc., are not supportable.
- ※ When connecting an USB memory, KRN100 pauses backup data download by Modbus function, and backup data printer function to recognize memory for a while (depending on the capacity, max. 30 sec).
- ※ If an USB memory's LED flashes, do not remove an USB memory, or it may damage to the data. If the damage of USB memory data occurs, you can find the saved data from KRN100 inner memory and save the desired file to an USB memory.

■ Firmware upgrade

Upgrades KRN100 firmware.

When upgrading firmware, parameters' set values are initialized.

- Setting range: -
- Factory default: Auto set

※ During firmware upgrade, alarm output, digital input and log file save, etc functions does not operate normally. Therefore, please take proper measures to prevent malfunction of KRN100 system before starting firmware upgrade. After completing firmware upgrade, you must turn OFF and ON the power of KRN100 to operate normally.

※ During firmware upgrading, when power turns OFF, firmware upgrade is not complete. When power turns ON again, KRN100 operates with previous firmware version. Try firmware upgrade again.



※ After completing firmware upgrade and OFF/ON the power, if KRN100 displays booting screen and does not operate normally, it may have damage to the inner firmware during firmware upgrade. It is required to repair

■ Backup data record setting [RECORD BACKUP SETUP]

Record Backup creates file when power ON regardless of starting/stopping record and saves the data to inner system memory (USB memory storage is available (Enable) by the set.) according the set record mode.

This parameter is useful to print the desired time data with backup data or check data by computer with DAQ Master (dedicated software).

Therefore, backup data set function is for printing the saved backup data at inner system memory and USB memory.

Move to RECORD BACKUP SETUP with the   keys and press the  key to enter RECORD BACKUP SETUP.

※ For printing backup data, KRN100 reads saved backup data in memory from beginning to end at first and starts printing. If backup data section is long or backup data is saved as low speed record mode, reading takes a lot of time. Therefore, print only for the desired section.

※ In graph mode, record speed is changed by Standard speed, Alarm, or Option Speed. Backup data is printed with Standard speed. Therefore, original printout and backup printout in graph mode may be different.

◎ Backup data record for clearing no recording paper [P.END Backup Print]

If there is no recording paper, the  icon flashes. After replacing recording paper, 「P.END BACKUP PRINT」 screen as below is activated.

Backup data recording function by P.END is same as RECORD BACKUP. Backup Data List cannot be changed.

Starting print by P.END Backup, it prints the data but backup data file date, file name, and backup record starting line.

A. Recorders

B. Indicators

C. Converters

D. Controllers

E. Thyristor Power Controllers

F. Pressure Transmitters

G. Temperature Transmitters

H. Accessories

KRN1000

KRN100

KRN50

KRN100 Series

■ Error

Displays error messages on screen and print data when error occurs.

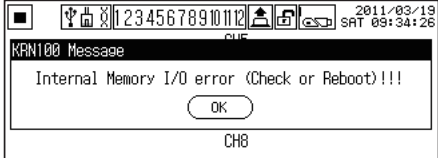
Message	Description	Message	Description
HHHH	In case Input Type is temperature sensor(thermocouple, RTD), if input value is higher than upper limit range, this error message flashes. If input value is within upper limit range, it is removed automatically. In case Input Type is analog (current, voltage), if input value is higher than over 10% of upper limit input range, this error message flashes. If input value is within 10% of upper limit input range, it is removed automatically. Prints HH.	LLLL	In case Input Type is temperature sensor (thermocouple, RTD), if input value is lower than lower limit range, this error message flashes. If input value is within lower limit range, it is removed automatically. In case Input Type is analog (current, voltage), if input value is lower than over 10% of lower limit input range, this error message flashes. If input value is within 10% of lower limit input range, it is removed automatically. Prints LL.
_H	In case Input Type is analog (current, voltage), if input value is higher than below 10% of upper limit input range, 「_H」 is displayed with current value to notify that current value is higher than upper limit input range. E.g.) When upper limit input range is 100 and current value is 102, it displays as 102_H.	_L	In case Input Type is analog (current, voltage), if input value is lower than below 10% of lower limit input range, 「_L」 is displayed with current value to notify that current value is lower than lower limit input range. E.g.) When lower limit input range is 0 and current value is -1, it displays as -1_L.
BURN	If input is break, this error message flashes. When input is connected, it is removed automatically. Prints BH (display value by break is High) or BL (display value by break is Low).	Inner Memory Access	 <p>As above screen, if excess error message for inner system memory Read/Write occurs frequently, please contact our service center.</p>
NONE	If universal input card is not connected, this error message flashes.		
ERR	When there is parameter setting error, card recognition error, etc, this error message flashes twice and KRN100 returns to previous screen.		

※ For more functions, refer to the user manual of KRN100.

■ Communication setting [COMMUNICATION SETUP]



Set the related parameters with communication output card (KRN-COM).

You can only check the item of COMMUNICATION SETUP by communication but cannot change the set.

This parameter is for setting and monitoring parameters from external upper system (PC and graph panel, etc) or transmitting the data to external devices by RS485, Ethernet, or USB Device communication.

It is recommended to use our dedicated software program DAQMaster for monitoring. If you want to develop monitoring program not using our DAQMaster program or to use the related Modbus program, please refer to user manual for communication.

Visit our website (www.autonics.com) to download DAQMaster program, and user manual for communication.

Move to COMMUNICATION SETUP with the   keys, press the  key to enter COMMUNICATION SETUP.

KRN100 does not supports RS485 port, Ethernet port at the same time for preventing system overload. If you change one as 「Enable」, the other is changed 「Disable」 automatically.

In case USB Device, it is able to set 「Enable」, 「Disable」 regardless of RS485 or Ethernet setting.

◎ Interface

Item	RS485	Ethernet	USB
Application standard	Compliance with EIA RS485	—	Compliance with USB V2.0
Max. connections	31 units (address: 1 to 127)	1 unit (number of occupations per a unit)	1 unit
Com. distance※1	Within max. 1km (below 9600bps)	Single cable within 100m (recommended over CAT5E)	Single cable within 1.5m
Com. method	Half duplex	Full duplex	—
Com. synchronization method	Asynchronous	Asynchronous	Asynchronous
Com. speed	2400/4800/9600/19200/38400bps	10/100Mbps	12Mbps (Full Speed)
Com. response wait time	5 to 99ms	—	—
Start Bit	1bit (fixed)	—	—
Data Bit	8bit (fixed)	—	—
Parity Bit	None, Odd, Even	—	—
Stop Bit	1, 2bit	—	—
Protocol	Modbus RTU	Modbus TCP	Modbus RTU

※1. When connecting through the network such as network hub (HUB) and gateway, etc, there is no distance limit, but it is recommended to use min. network. Please use communication cables which is satisfied the below conditions.

- RS485 communication: Shield Twist Pair over AWG24, characteristic impedance 100Ω, capacity component 50 pF/m cable length max. 1km
- Ethernet communication: Over CAT5E, cable max. length: 100m
- USB communication: Single cable built-in ferrite core within 1.5m

100mm Hybrid Recorder

◎ Application of system organization

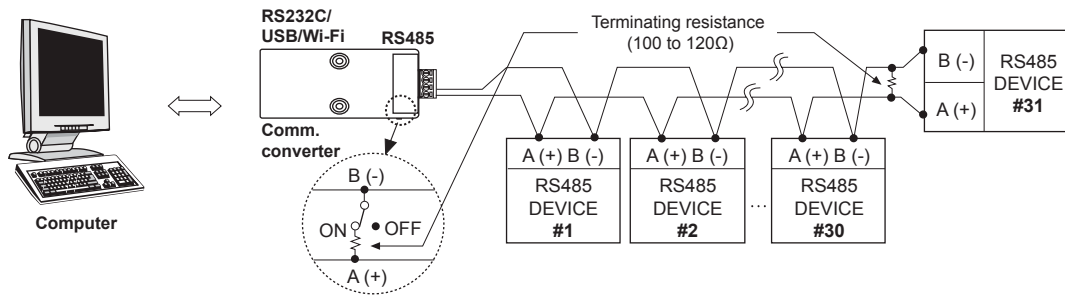

※It is recommended to use Autonics communication converter; SCM-WF48 (Wi-Fi to RS485-USB wireless communication converter, sold separately), SCM-US48I (USB to RS485 converter, sold separately), SCM-38I (RS232C to RS485 converter, sold separately). Please use twisted pair wire, which is suitable for RS485 communication, for SCM-WF48 and SCM-US48I.

A. Recorders
B. Indicators
C. Converters
D. Controllers
E. Thyristor Power Controllers
F. Pressure Transmitters
G. Temperature Transmitters
H. Accessories

Adjustment

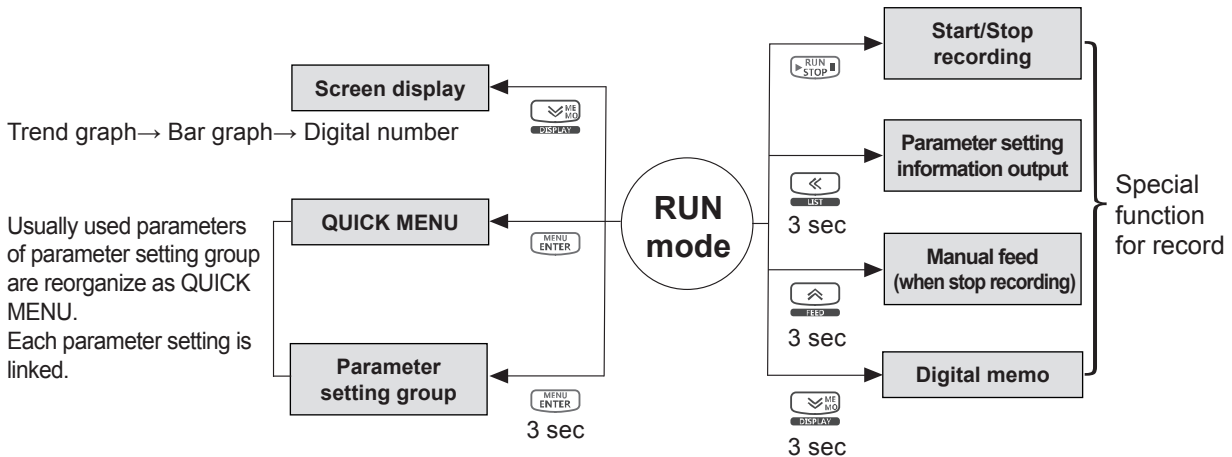

KRN1000
KRN100
KRN50

Display Changing

KRN100 displays measuring value as trend graph, bar graph, and digital number display (1-channel, 8-channel, 12-channel). You can select one by the key.

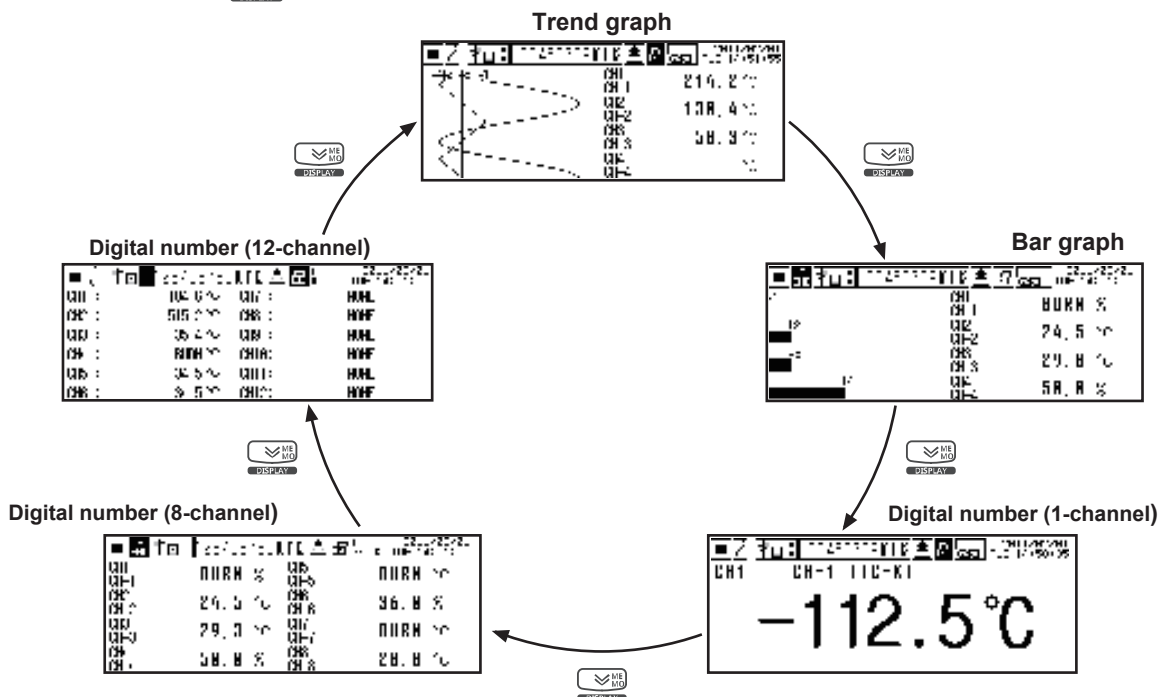

KRN100 Series

QUICK MENU

QUICK MENU [1]					
CH	TYPE	DOT	UNIT	PEN COLOR	
CH-1	TC-K	0.0	'C	Violet	▶▶▶▶
SET	SET	SET	SET	SET	NEXT

QUICK MENU consists of usually used parameters for quickly parameter setting.

Page	Parameter	Description	Linked parameters
QUICK MENU [1]	CH	Select channel for the QUICK MENU [1] setting	
	TYPE	Input type	[INPUT SETUP]-[Input Type]
	DOT	Decimal point	[INPUT SETUP]-[Range/Scale Point]
	UNIT	Display/Temperature unit	[INPUT SETUP]-[Display/Temp Unit]
	PEN COLOR	Pen color	[INPUT SETUP]-[Pen Color]
QUICK MENU [2]	CH	Select channel for the QUICK MENU [2] setting	
	LOW RANGE	Low-limit input value or graph scale value	[INPUT SETUP]-[Low Range] or [INPUT SETUP]-[Low Graph Scale]
	HIGH RANGE	High-limit input value or graph scale value	[INPUT SETUP]-[High Range] or [INPUT SETUP]-[High Graph Scale]
	LOW SCALE	Low-limit scale value	[INPUT SETUP]-[Low Scale]
	HIGH SCALE	High-limit scale value	[INPUT SETUP]-[High Scale]
QUICK MENU [3]	PRINT MODE	Record mode	[RECORD SETUP]-[Record Mode]
	PRINT SPEED	Standard record speed	[RECORD SETUP]-[Standard Speed]
	PRINT MEMO	Digital memo period	[RECORD SETUP]-[Memo Period]
	BACK LIGHT	LCD backlight	[SYSTEM SETUP]-[Backlight]
	LCD ON/OFF	LCD backlight ON/OFF	[SYSTEM SETUP]-[Backlight On/Off]
QUICK MENU [4]	USB REC	Memory save	[FILE/MEMORY SETUP]-[USB LogData Save]
	USB COPY	Call USB COPY window	[FILE/MEMORY SETUP]-[USB Memory Copy/Move]
	UPGRADE	Call upgrade window	[USER/INFORMATION SETUP]-[Firmware Upgrade]
	CANCEL	Cancel the settings	
	SAVE	Save the setting of QUICK MENU [1] to [4]	

QUICK MENU Setting

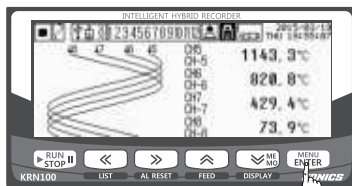

Press the **MENU ENTER** key once in RUN mode and it enters to QUICK MENU. QUICK MENU consists of usually used parameters for quickly parameter setting.



Set the keys following the each parameter. Press the NEXT (**MENU ENTER**) key and it moves to next page.

E.g.)When changing the temperature unit (°C→°F), press the SET (**FEED**) key.

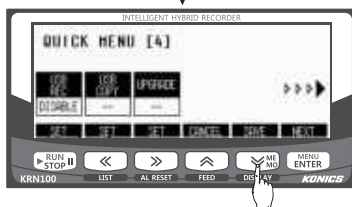

After completing the setting, press the SAVE (**ME DISP**) key at QUICK MENU [4] and save the settings. It returns to RUN mode.

100mm Hybrid Recorder

Example of QUICK MENU Setting

In case of CH1, recording as input type=TC-U, low-limit input value=300, standard record speed=240mm/h.

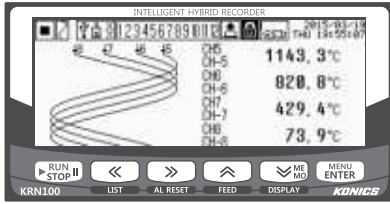

Press the **MENU ENTER** key in RUN mode to enter QUICK MENU.

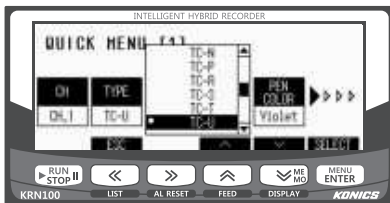

Press the **SET** (**←**) key at QUICK MENU[1] and below screen is displayed. Set input type[TYPE] as TC-U by pressing **SET** (**↑**), **ME MD** (**↓**) keys and press the **MENU ENTER** key.

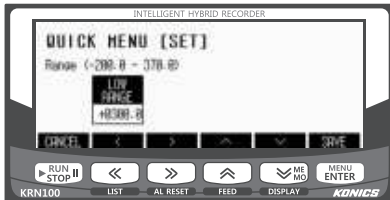

Press the **NEXT** (**MENU ENTER**) key once and it moves to QUICK MENU [2]. Press the **SET** (**←**) key using **←**, **→**, **↑**, **↓** keys to set low-limit input range[LOW RANGE] as 300. Press the **MENU ENTER** key.

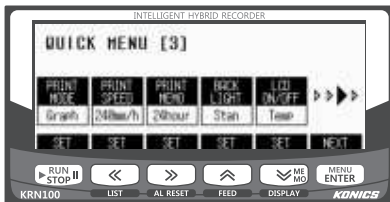

Press the **NEXT** (**MENU ENTER**) key once and it moves to QUICK MENU [3]. Press the **SET** (**←**) key and set standard record speed [PRINT SPEED] as 240mm/h. Press the **MENU ENTER** key.

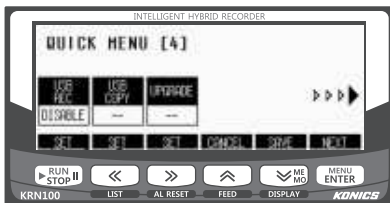

Press the **NEXT** (**MENU ENTER**) key once and it moves to QUICK MENU [4]. Press the **SAVE** (**ME MD**) key to save the settings of QUICK MENU [1] to [4] and it returns to RUN mode.

A. Recorders

B. Indicators

C. Converters

D. Controllers

E. Thyristor Power Controllers

F. Pressure Transmitters

G. Temperature Transmitters

H. Accessories

KRN1000

KRN100

KRN50

KRN100 Series

Parameters

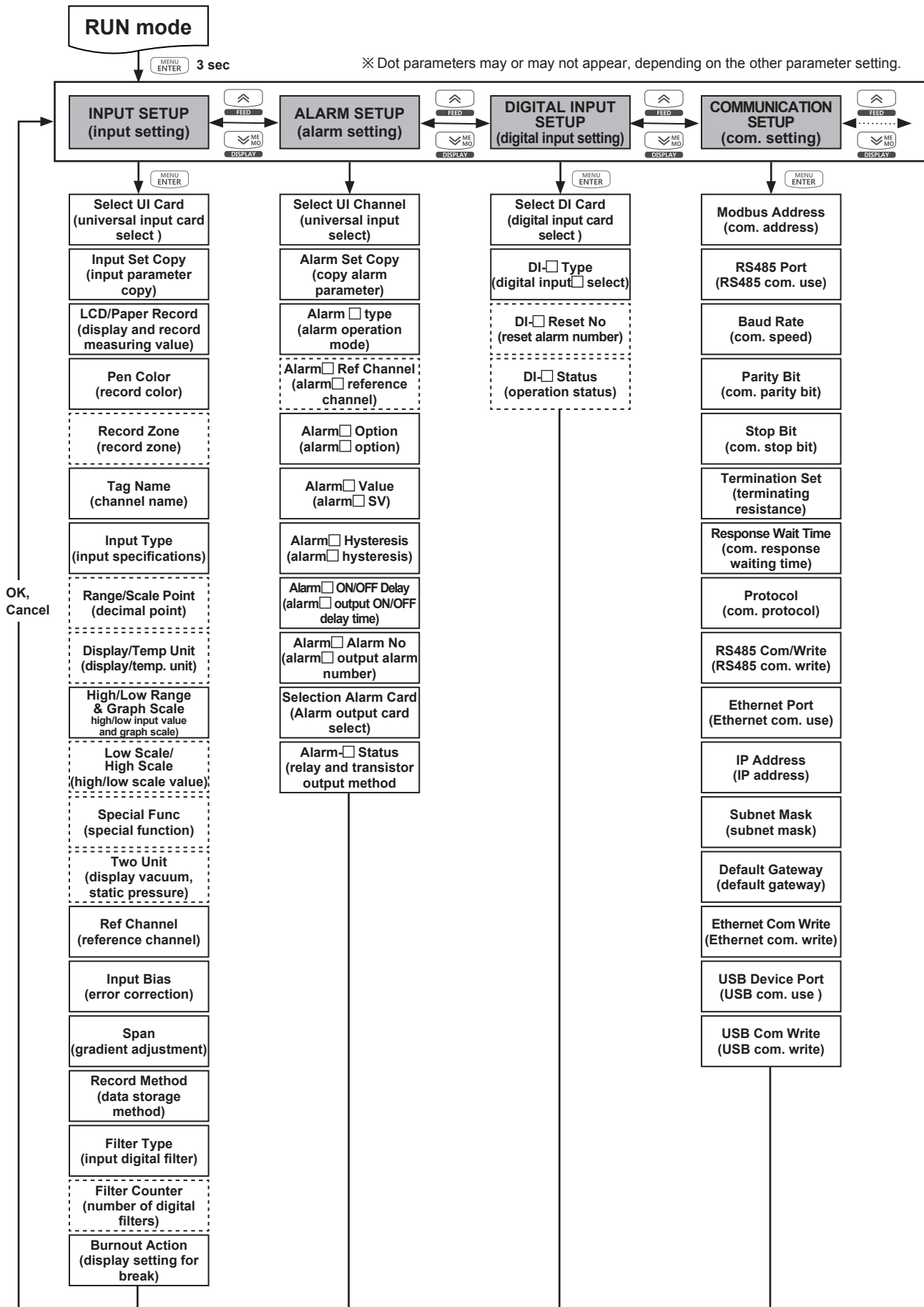

100mm Hybrid Recorder

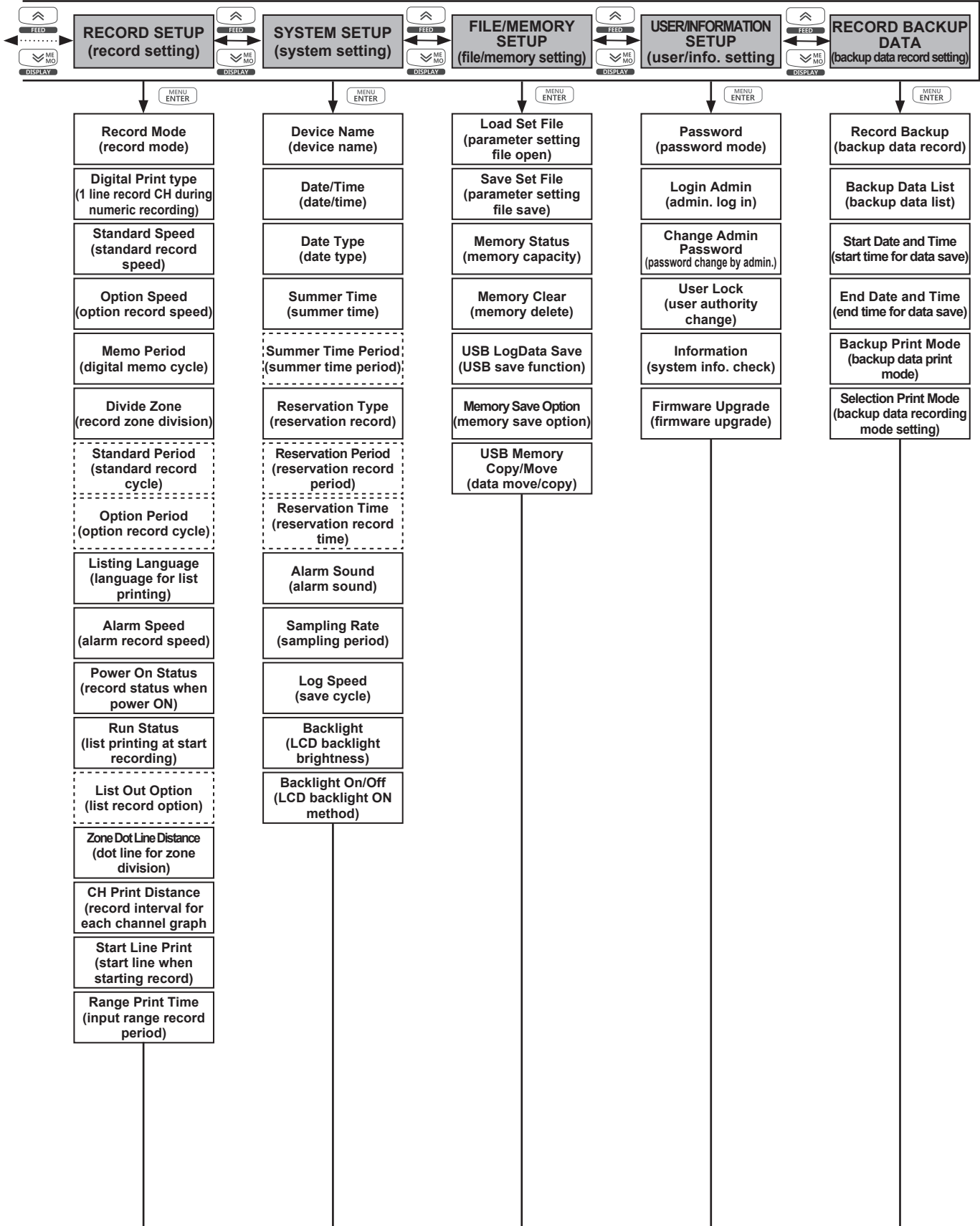

- A. Recorders
- B. Indicators
- C. Converters
- D. Controllers
- E. Thyristor Power Controllers
- F. Pressure Transmitters
- G. Temperature Transmitters
- H. Accessories

- KRN1000
- KRN100
- KRN50

KRN100 Series

Factory Default

Input setting group [INPUT SETUP]

Parameter	Default	Parameter	Default	Parameter	Default	Parameter	Default
Select UI Card	Auto set	Input Type	TC-K	Low Scale/High Scale	—	Record Method	Instant
Input Set Copy	CH Select	Range/Scale Point	0.0	Special Function	None	Filter Type	None
LCD/Paper Record	ON	Display/Temp Unit	TC, RTD °C	Two Unit	—	Filter Counter	—
Pen Color	Auto set		Analog	%	Reference Channel	—	Burnout Action
Record Zone	None	High/Low Range & Graph Scale	Low	-200.0	Input Bias	0.0	
Tag Name	CH-1 to 12		High	1350.0	Span	—	

Alarm setting group [ALARM SETUP]

Parameter	Default	Parameter	Default	Parameter	Default	Parameter	Default
Select UI Card	Auto set	Alarm <input type="checkbox"/> Ref Channel	—	Alarm <input type="checkbox"/> Hysteresis ^{※1}	0.0	Alarm- <input type="checkbox"/> Status ^{※1}	NO
Alarm Set Copy	CH Select	Alarm <input type="checkbox"/> Option ^{※1}	None	Alarm <input type="checkbox"/> ON/OFF Delay ^{※1}	0s		
Alarm1 Type ^{※1}	PV.Hi	Alarm1 Value ^{※1}	1350.0	Alarm <input type="checkbox"/> Alarm No ^{※1}	None		
Alarm 2 to 4 Type ^{※1}	None	Alarm 2 to 4 Value ^{※1}	—	Select Alarm Card	Auto set		

Digital input setting group [DIGITAL INPUT SETUP]

Parameter	Default	Parameter	Default	Parameter	Default	Parameter	Default
Select DI Card	Auto set	DI- <input type="checkbox"/> Type	None	DI- <input type="checkbox"/> Reset No	—	DI- <input type="checkbox"/> Status	—

Communication setting group [COMMUNICATION SETUP]

Parameter	Default	Parameter	Default	Parameter	Default	Parameter	Default
Modbus Address	1	Stop Bit	2	RS485 Com Write	Enable	Default Gateway	—
RS485 Port	Enable	Termination Set	Disable	Ethernet Port	Disable	Ethernet Com Write	—
Baud Rate	9600	Response Wait Time	20ms	IP Address	—	USB Device Port	Enable
Parity Bit	None	Protocol	Modbus RTU	Subnet Mask	—	USB Com Write	Enable

Record setting group [RECORD SETUP]

Parameter	Default	Parameter	Default	Parameter	Default	Parameter	Default
Record Mode	Graph	Divide Zone	None	Power On Status	Hold	Start Line Print	ON
Digital Print type	TwoCH	Standard Period	—	Run Status	OFF	Range Print Time	Disable
Standard Speed	20mm/h	Option Period	—	List Out Option	Standard		
Option Speed	20mm/h	Listing Language	English	Zone Dot Line Distance	4.0mm		
Memo Period	2hour	Alarm Speed	20mm/h	CH Print Distance	20.0mm		

System setting group [SYSTEM SETUP]

Parameter	Default	Parameter	Default	Parameter	Default	Parameter	Default
Device Name	KRN100 Recorder	Summer Time Period	—	Alarm Sound	OFF	Backlight On/Off	Temp
Date/Time	Default set	Reservation Type	Disable	Sampling Rate	125ms		
Date Type	yyyy/mm/dd	Reservation Period	—	Log Speed	1s		
Summer Time	Disable	Reservation Time	—	Backlight	Standard		

File/Memory setting group [FILE/MEMORY SETUP]

Parameter	Default	Parameter	Default	Parameter	Default	Parameter	Default
Load Set File	None	Memory Status	0%	USB LogData Save	Disable	USB Memory Copy/Move	USB Copy/ Move..
Save Set File	Select...	Memory Clear	Clear...	Memory Save Option	Stop		

■ User/Information setting group [USER INFORMATION SETUP]

Parameter	Default	Parameter	Default	Parameter	Default
Password	Disable	Change Admin Password	—	Information	Display...
Login Admin	—	User Lock	OFF	Firmware Upgrade	Auto set

■ Backup data record setting group [RECORD BACKUP SETUP]

Parameter	Default	Parameter	Default	Parameter	Default
Record Backup	Stop	Start Date and Time	0000/00/00 00:00:00	Backup Print Mode	Graph
Backup Data List	File Not Found!!	End Date and Time	0000/00/00 00:00:00	Select Print Mode	Graph

※1. Alarm Type to Alarm No are displayed by the number of connected alarm cards.

※ Shaded parameters are depending on other parameters' SV. Refer to the more information of the parameter.

Proper Usage

- Do not use the unit outdoors. Failure to follow this instruction may result in electric shock or shortening the life cycle of the unit.
- When connecting the power input or measuring input, power cable should be over AWG20 (0.50mm²). Make sure to tighten the terminal screw bolt above 0.74 N·m to 0.90 N·m.
- Use the unit within the rated specifications. Failure to follow this instruction may result in fire or shortening the life cycle of the unit.
- Do not use loads beyond the rated switching capacity of the relay contact. Failure to follow this instruction failure, contact melt, contact failure, relay broken, or fire, etc.
- When connecting magnet contact as load of relay contact output, connect surge absorber on coil part of contact. Failure to follow this instruction may result in malfunction.
- Do not use water or oil-based detergent when cleaning the unit. Use dry cloth to clean the unit. Failure to follow this instruction may result in electric shock or fire.
- Do not use the unit where flammable or explosive gas, humidity, direct sunlight, vibration, or impact may be present. Failure to follow this instruction may result in fire or explosion.
- Keep dust and wire residue from flowing into the unit. Failure to follow this instruction may result in fire or malfunction.
- Check the polarity of the power contact before wiring the unit. Failure to follow this instruction may result in fire or explosion.
- Check the polarity of the terminal when connecting a temperature sensor to the unit. Failure to follow this instruction may result in cause malfunction.
- Check the connection diagram of this manual before supplying power. Failure to follow this instruction may result in fire.
- Do not touch terminal during dielectric or insulation resistance test. Failure to follow this instruction may result in electric shock.
- Use insulation transformer and noise filter power for too much noise from the power. Attach noise filter on the grounded panel, etc. Use short cables for noise filter output part and power terminal of the unit. Failure to follow this instruction may result in product damage, malfunction by surge, etc.
- Before connecting temperature sensor (thermocouple, RTD) and analog (voltage, current) input, set jumper pin of universal input card as input type. Failure to follow this instruction may result in product damage and malfunction.
- Do not connect or separate input, output cards while power is ON. Failure to follow this instruction may result in serious damage.
- Do not open the cover or insert your finger during operation. Failure to follow this instruction may result in electric shock.
- Do not control the alarm output or measure the data during firmware upgrade. Failure to follow this instruction may result in malfunction. Alarm output, contact input, data measurement do not operate normally.
- After completing firmware upgrade, check the complete message and turn OFF to ON the power. Failure to follow this instruction may result in malfunction.
- All parameter set value is reset after firmware upgrade. It may not operate as same way with before upgrade operation.
- Use voltage output of transmitter power output card only for transmitter power. Failure to follow this instruction may result in output module damage.

KRN1000

KRN100

KRN50